



Product Change Notification

4703, 4706, 4709 Circuit Breakers













PCN Number:	EMEPCN-0007
Revision:	1.03
Issue Date:	2021-02-21
Effective Date:	2021-04-01
Author:	Egis Mobile Electric

1 Product Identification

1.1 Product Data

	Current Product	New Product
Product Name	Circuit Breaker, Surface Mount, Various Current Values	Circuit Breaker, Surface Mount, Various Current Values
Egis Part Numbers	4703-xxx	4703-xxx
Egis Part Numbers	4706-xxx	4706-xxx
Egis Part Numbers	4709-xxx	4709-xxx
Date Codes	01/2018 – 03/2021	04/2021 →

1.2 Means of Distinguishing Changed Products

		Remark				
Product Number	<input checked="" type="checkbox"/>	Old product numbers 4703-xxx, 4706-xxx, and 4709-xxx will remain. New Revisions are equivalent in functionality and performance to old revisions				
Date Code Label	<input checked="" type="checkbox"/>	New products will be built with date codes 04/2021 and beyond				
Other	<input checked="" type="checkbox"/>	4703: Housing Footprint increased to size of 4709. Nuts with integrated serrated flanges replaced with nuts with integrated captive external tooth lock washers				
		<table border="1"> <thead> <tr> <th>Current Rev 4703-xxx, 4706-xxx</th> <th>New Versions 4703-xxx, 4706-xxx</th> </tr> </thead> <tbody> <tr> <td></td> <td></td> </tr> </tbody> </table>	Current Rev 4703-xxx, 4706-xxx	New Versions 4703-xxx, 4706-xxx		
		Current Rev 4703-xxx, 4706-xxx	New Versions 4703-xxx, 4706-xxx			
						
<table border="1"> <tbody> <tr> <td></td> <td></td> </tr> </tbody> </table>						
						
Current Rev 4709-xxx	New Versions 4709-xxx					



2 Description and Reason of Change

AVL	<input type="checkbox"/>	Product Improvement	<input checked="" type="checkbox"/>
Material	<input type="checkbox"/>	BIOS Release	<input type="checkbox"/>
Assembly Process	<input checked="" type="checkbox"/>	Firmware Release	<input type="checkbox"/>
Assembly BOM	<input checked="" type="checkbox"/>	Datasheet / Manual	<input type="checkbox"/>
Testing	<input type="checkbox"/>	DFM	<input type="checkbox"/>
Manufacturing Site	<input checked="" type="checkbox"/>	Other	<input checked="" type="checkbox"/>

A new version has been created of the Egis Thermal Circuit Breaker Series in order to increase made in USA raw materials. The new revision of the 4703, 4706, & 4709 circuit breakers are not officially Made in the USA. For the 4706 and 4709 series, product differences are very minor. For 4703 there is a physical size difference for the product which provides several advantages which Egis felt was compelling to offer including a much larger cable terminal landing area.

3 Impact of change (positive or negative) on fit, form, function & reliability

3.1 Quality and Reliability

The changes listed in Section 2 will have no negative effect on the overall functionality, performance specifications, quality and reliability of the product. The new revision offers the same power input and output wire sizes.

As a result of the improvements the new product incorporates, the new product warranty for the new revisions will maintain the existing 4 years of warranty against product failure.

3.3 Physical Compatibility

The new revision of the 4703 series will have a new housing manufactured in the USA. Section 5 of this PCN outlines the new slightly increased product size. For the 4706 & 4709 series circuit breakers, no material change is physical size will be seen.

For all thermal circuit breaker series. The serrated flange nut in the old revision will be replaced by a captive external lock washer nut which provides similar torque maintaining support and does not require a separate locking washer that otherwise could be lost or not applied. All new revision products utilize the same size terminal attachment hardware and mounting hole sizes are the same as well.

5 Product Dimensional Comparison

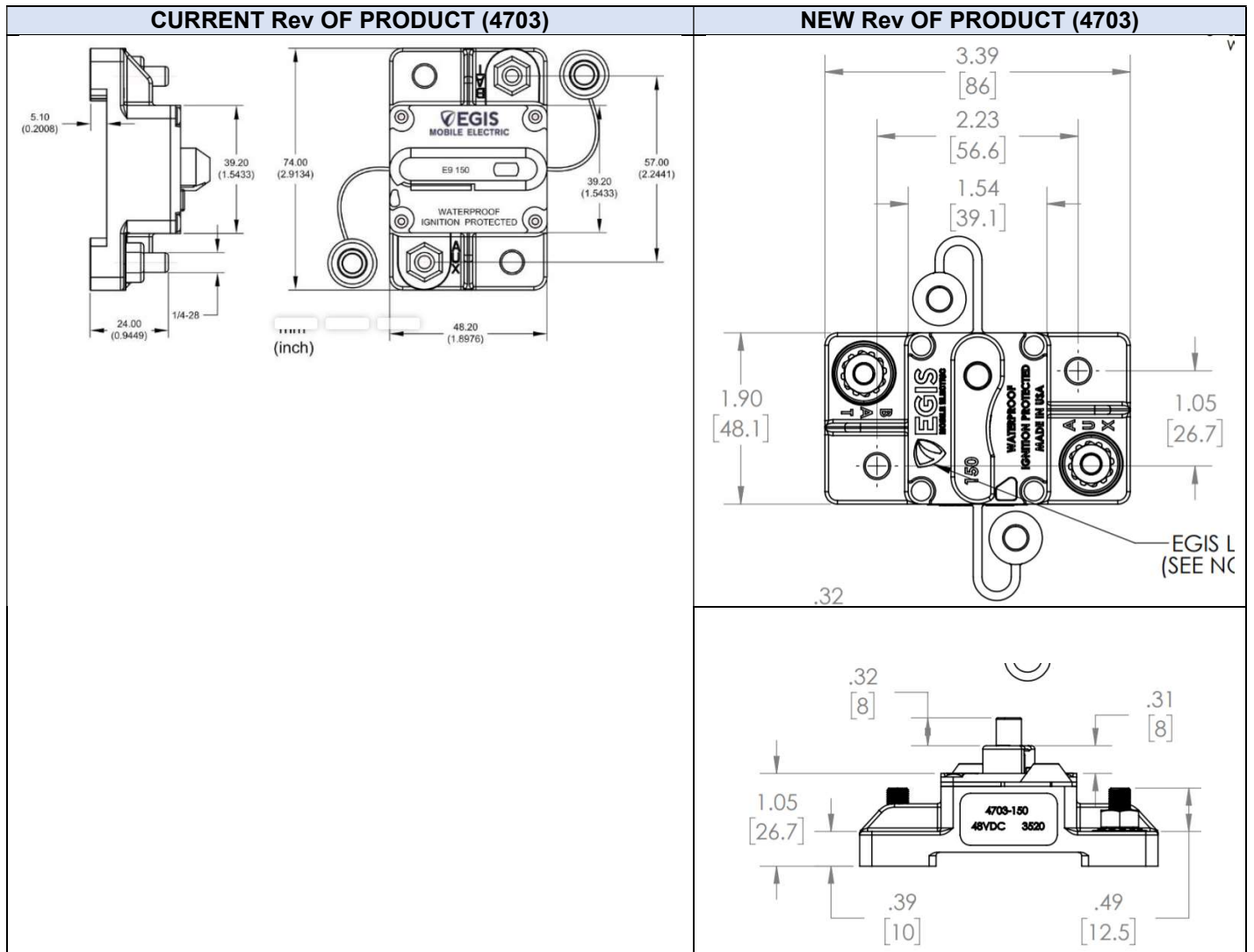

CURRENT Rev OF PRODUCT (4706)	NEW Rev OF PRODUCT (4706)

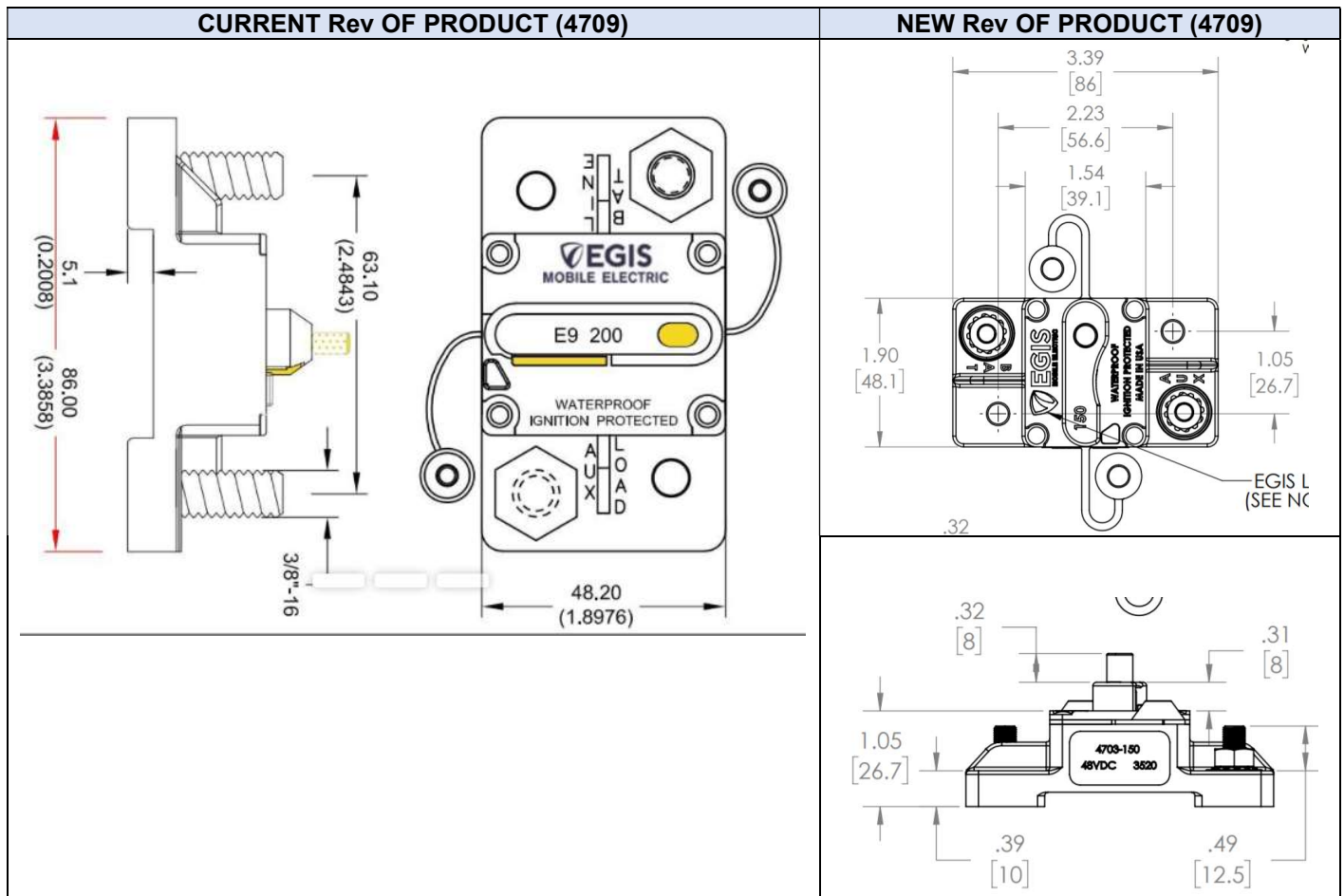

6 Product / Revision Discontinuation

After the release of this PCN there will be a short transition time whereby the incumbent Rev 4703, 4706, & 4709 product may be shipped to fulfill orders. After the completion of the transition, only the new revision will be available. This includes products that fall under the RMA process where Egis Mobile Electric will provide the new revision product for warranty replacement purposes of the original revision of all product part numbers

7 Contact Information

Phone	+1-360-768-1211
Email	sales@egismobile.com